

Embedded Solutions



microSD Cards

microSDHC520I

The ideal choice for small form factor devices with high performance demands in extreme temperatures from -40°C to 85°C, Transcend's Extended Temperature microSDHC520I cards offer high-speed Class 10 data transfer rates, and are specifically designed for industrial applications. To ensure reliability and endurance, these microSD cards are manufactured using high-quality MLC NAND Flash chips and undergo extensive reliability testing at all stages of production at an attractive price.

Hardware Features

- Compliant with RoHS standards
- MLC NAND flash
- Compliant with Speed Class 10
- Compliant with SD specification 3.01
- Promised operational reliability in a wide temperature range (from -40°C to 85°C)

Firmware Features

- Supports Content Protection for Recorded Media (CPRM)
- Built-in ECC (Error Correction Code) functionality
- Wear-Leveling
- Early Move

Ordering Information

8GB	TS8GUSD520I
-----	-------------

Specifications

Appearance	Dimensions	11 mm x 15 mm x 1 mm (0.43" x 0.59" x 0.04")
	Form Factor	microSD flash card
Storage	Flash Type	MLC NAND flash
	Capacity	8 GB
Operating Environment	Operating Voltage	2.7V ~ 3.6V
	Drop Test	1.5m free fall
	Operating Temperature	Wide Temp. -40°C (-40°F) ~ 85°C (185°F)
	Storage Temperature	-40°C (-40°F) ~ 85°C (185°F)
	Humidity	0% ~ 95%
	Shock	Acceleration: 490 m/s ² (standard holding time: 11 ms, semi-sine wave, velocity change: 3.44 m/s)
	Vibration (Operating)	20 G (peak-to-peak), 20 Hz ~ 2000 Hz (frequency)
Power	Power Consumption (Max.)	0.72 watt(s)
Performance	Read Speed (Max.)	up to 24 MB/s
	Write Speed (Max.)	up to 16 MB/s
	Terabytes Written (TBW)	up to 15 TBW
Warranty	Certificate	CE / FCC / UKCA
	Warranty	Three-year Limited Warranty

Mechanical Dimensions

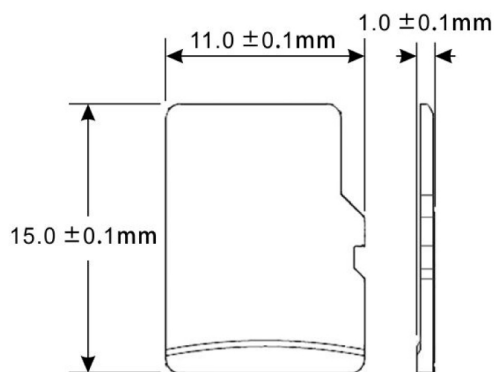

Product specifications are subject to change without notice. Pictures shown may differ from actual products. Total accessible capacity varies depending on operating environment. Due to the complexity and variety of industrial applications, Transcend cannot guarantee 100% compatibility with all platforms and under all scenarios. For special applications and environments, it is strongly suggested that you contact Transcend beforehand for clarification.